

INVERTER-TROLLEY



BENEFITS

- ✓ 100% steel; 0% plastic
- ✓ 4 wheel system for easy maneuverability
- ✓ Corrosion free & long lasting trolley body
- ✓ Safe & has rugged design

850VA TROLLEY

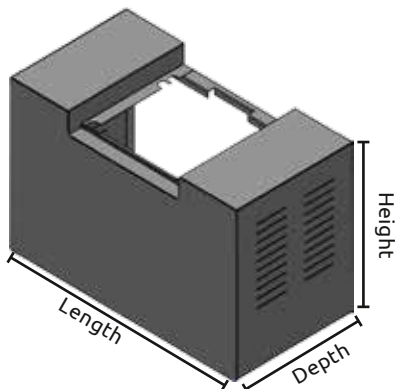

SPECIFICATION

TROLLEY	850VA	1100VA
Material	Mild steel	Mild steel
Dimensions (mm)	L575×D296×H377	L518×D559×H374
Packing dimensions (mm)	L585×D306×H387	L528×D570×H390

1500VA & 2000VA TROLLEY

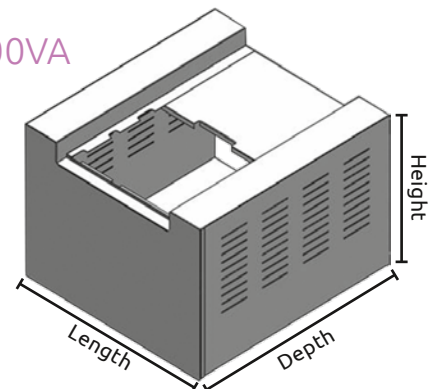

AVR DELTA SERIES 80V

(3000VA)



APPLICATION



AC-1 Ton

SCHEMATIC

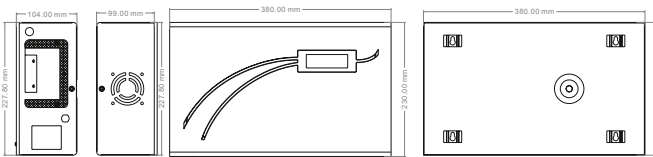

BENEFITS

- ✓ Elegant and modern design.
- ✓ 5 Relays ensure rigorous and high precision voltage outputs.
- ✓ Instant transformer of power through zero-crossing detection.
- ✓ High efficiency toroidal transformer.
- ✓ Full protection: over voltage, under voltage, overheat, short circuit and overload.
- ✓ Selectable 6s/180s delay time.
- ✓ Air conditioner starter push offers very high current for 30 seconds to allow air conditioner to start.
- ✓ USB charger let you charge your smartphone, tablet, or any other peripheral with the built-in USB charger.
- ✓ Auto-run after Overload protection.

FEATURES



FARBER-COOLER™

Offers very high current for 30 seconds to allow air conditioners to start



FARBER-TRANSFER™

Instant transfer of power through zero-crossing detection



FARBER-TECHTOR™

Protects against over voltage



FARBER-TECHTOR™

Protects against under voltage



FARBER-TECHTOR™

Protects against over heat



FARBER-TECHTOR™

Protects against overload



LCD FEATURES SPECIFICATION

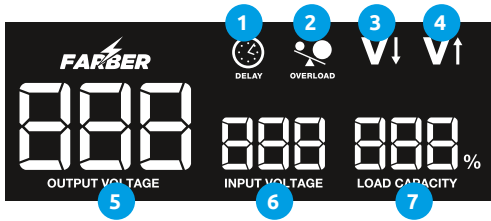

1. Delay
2. Overload protection
3. Low voltage protection
4. Over voltage protection
5. Output voltage
6. Input voltage
7. Load capacity

MODEL NUMBER	FA-AVR-80V-3000VA
Capacity	3000VA
Technology	FARBER-COLER/FARBER-TRANSFER
Transformer	Ultraslim toroidal transformer
Material	Metal
INPUT	
Input Voltage	80-220V
Input Frequency	45-65Hz
OUTPUT	
Rated Output Voltage	220V/230V
Output Precision	±8%
Output Frequency	Synchronized with input frequency
Efficiency	>97%
DISPLAY	
Digital Display	Input Voltage & Output Voltage
Green LED	power on
Yellow LED	Delaying
Red LED	Protecting
PROTECTIONS	
Over Voltage	Output Cutoff + warning
Under Voltage	Output Cutoff + warning
Overheat	Output Cutoff + warning
Short Circuit	Circuit breaker trip
Overload	Output Cutoff + warning
Surge	MOV
Delay Time	6s / 180 selectable
OTHERS	
Certifications	CE, SON, SB, SASD
Peripherals	USB Charging Port, Smart Cooling Fan
Operating Temperature	0°C-40°C
Storage Temperature	-15°C-45°C
Operating Humidity	10%-90%, Non-condensing
Dimensions	38.0 x 23.0 x 9.9
Quantity	1 piece



FARBER-TECHTOR™
Protects against short circuit



FARBER-WARNER™
In case of any fault or emergency, an alarm will sound



FARBER-RIGOUR™
5 relays ensure rigorous and high precision voltage outputs



FARBER-RESTARTER™
AVR will auto-run after overload protection



USB charger (OPTIONAL)
Charge your smartphone, tablet, or any other peripheral with the built-in USB charger

AVR DELTA SERIES 80V

(7000VA)



APPLICATION



AC-2 Tons

SCHEMATIC

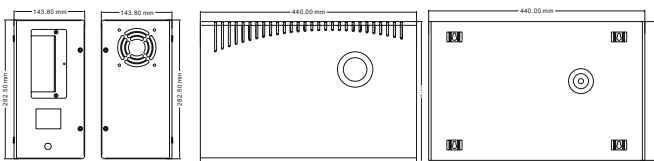

BENEFITS

- ✓ Elegant and modern design.
- ✓ 5 Relays ensure rigorous and high precision voltage outputs.
- ✓ Instant transfer of power through zero-crossing detection.
- ✓ High efficiency toroidal transformer.
- ✓ Full protection: over voltage, under voltage, overheat, short circuit and overload.
- ✓ Selectable 6s/180s delay time.
- ✓ Air conditioner starter push offers very high current for 30 seconds to allow air conditioner to start.
- ✓ USB charger let you charge your smartphone, tablet, or any other peripheral with the built-in USB charger.
- ✓ Auto-run after Overload protection.

FEATURES



FARBER-COOLER™

Offers very high current for 30 seconds to allow air conditioners to start



FARBER-TRANSFER™

Instant transfer of power through zero-crossing detection



FARBER-TECHTOR™

Protects against over voltage



FARBER-TECHTOR™

Protects against under voltage



FARBER-TECHTOR™

Protects against over heat



FARBER-TECHTOR™

Protects against overload



LCD FEATURES

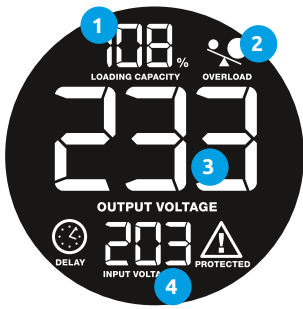

1. Loading capacity percentage
2. Overload warning
3. Output voltage
4. Input voltage

DISPLAY WARNINGS



Over voltage warning



Under voltage warning

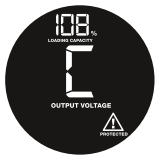

Overheat warning

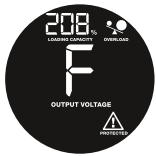

Overload warning

SPECIFICATION

MODEL NUMBER	FA-AVR-80V-7000VA
Capacity	7000VA
Technology	FARBER-COLER/FARBER-TRANSFER
Transformer	Ultraslim toroidal transformer
Material	Metal
INPUT	
Input Voltage	80-220V
Input Frequency	45-65Hz
OUTPUT	
Rated Output Voltage	220V/230V
Output Precision	±8%
Output Frequency	Synchronized with input frequency
Efficiency	>97%
DISPLAY	
Digital Display	Input Voltage & Output Voltage
Green LED	power on
Yellow LED	Delaying
Red LED	Protecting
PROTECTIONS	
Over Voltage	Output Cutoff + warning
Under Voltage	Output Cutoff + warning
Overheat	Output Cutoff + warning
Short Circuit	Circuit breaker trip
Overload	Output Cutoff + warning
Surge	MOV
Delay Time	6s / 180 selectable
OTHERS	
Certifications	CE, SON, SB, SASD
Peripherals	USB Charging Port, Smart Cooling Fan
Operating Temperature	0°C-40°C
Storage Temperature	-15°C-45°C
Operating Humidity	10%-90%, Non-condensing
Dimensions	44.0 x 28.25 x 14.58
Quantity	1 piece



FARBER-TECHTOR™
Protects against short circuit



FARBER-WARNER™
In case of any fault or emergency, an alarm will sound



FARBER-RIGOUR™
5 relays ensure rigorous and high precision voltage outputs



FARBER-RESTARTER™
AVR will auto-run after overload protection



USB charger (OPTIONAL)
Charge your smartphone, tablet, or any other peripheral with the built-in USB charger

AVR PI SERIES 100V

(3000VA)

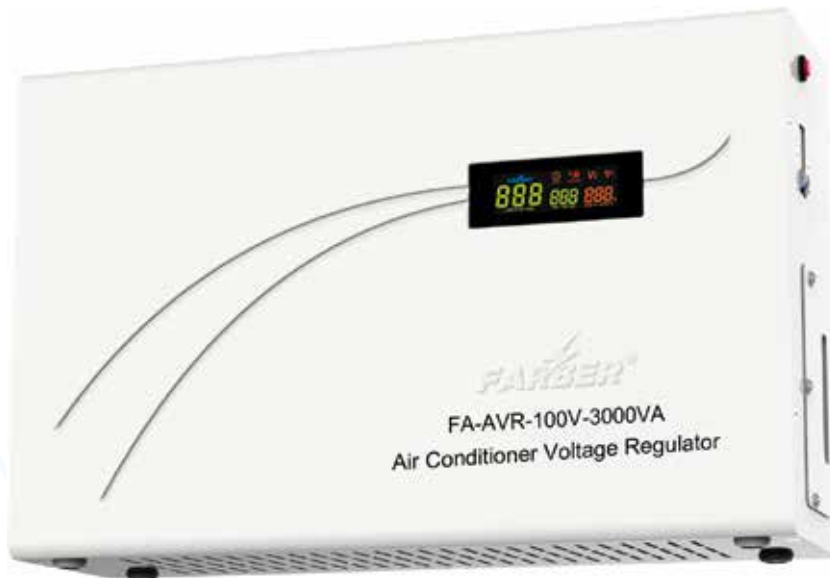

APPLICATION



AC-1 Ton

SCHEMATIC

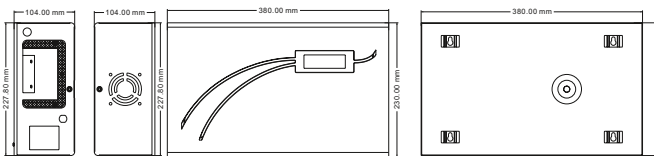

BENEFITS

- ✓ Elegant and modern design.
- ✓ 5 Relays ensure rigorous and high precision voltage outputs.
- ✓ Instant transformer of power through zero-crossing detection.
- ✓ High efficiency toroidal transformer.
- ✓ Full protection: over voltage, under voltage, overheat, short circuit and overload.
- ✓ Selectable 6s/180s delay time.
- ✓ Air conditioner starter push offers very high current for 30 seconds to allow air conditioner to start.
- ✓ USB charger let you charge your smartphone, tablet, or any other peripheral with the built-in USB charger.
- ✓ Auto-run after Overload protection.

FEATURES



FARBER-COOLER™

Offers very high current for 30 seconds to allow air conditioners to start



FARBER-TRANSFER™

Instant transfer of power through zero-crossing detection



FARBER-TECHTOR™

Protects against over voltage



FARBER-TECHTOR™

Protects against under voltage



FARBER-TECHTOR™

Protects against over heat



FARBER-TECHTOR™

Protects against overload



LCD FEATURES SPECIFICATION

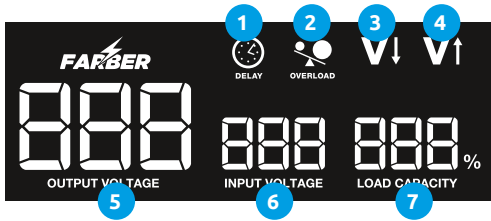

1. Delay
2. Overload protection
3. Low voltage protection
4. Over voltage protection
5. Output voltage
6. Input voltage
7. Load capacity

MODEL NUMBER		FA-AVR-100-3000VA
Capacity	3000VA	
Technology	FARBER-COLER/FARBER-TRANSFER	
Transformer	Ultraslim toroidal transformer	
Material	Metal	
INPUT		
Input Voltage	100-220V	
Input Frequency	45-65Hz	
OUTPUT		
Rated Output Voltage	220V/230V	
Output Precision	±8%	
Output Frequency	Synchronized with input frequency	
Efficiency	>97%	
DISPLAY		
Digital Display	Input Voltage & Output Voltage	
Green LED	power on	
Yellow LED	Delaying	
Red LED	Protecting	
PROTECTIONS		
Over Voltage	Output Cutoff + warning	
Under Voltage	Output Cutoff + warning	
Overheat	Output Cutoff + warning	
Short Circuit	Circuit breaker trip	
Overload	Output Cutoff + warning	
Surge	MOV	
Delay Time	6s / 180 selectable	
OTHERS		
Certifications	CE, SON, SB, SASD	
Peripherals	USB Charging Port, Smart Cooling Fan	
Operating Temperature	0°C-40°C	
Storage Temperature	-15°C-45°C	
Operating Humidity	10%-90%, Non-condensing	
Dimensions	38.0 x 23.0 x 10.4	
Quantity	1 piece	



FARBER-TECHTOR™
Protects against short circuit



FARBER-WARNER™
In case of any fault or emergency, an alarm will sound



FARBER-RIGOUR™
5 relays ensure rigorous and high precision voltage outputs



FARBER-RESTARTER™
AVR will auto-run after overload protection



USB charger (OPTIONAL)
Charge your smartphone, tablet, or any other peripheral with the built-in USB charger

AVR PI SERIES 100V

(7000VA)



APPLICATION



AC-2 Tons

SCHEMATIC

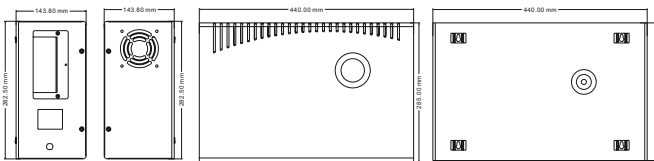

BENEFITS

- ✓ Elegant and modern design.
- ✓ 5 Relays ensure rigorous and high precision voltage outputs.
- ✓ Instant transformer of power through zero-crossing detection.
- ✓ High efficiency toroidal transformer.
- ✓ Full protection: over voltage, under voltage, overheat, short circuit and overload.
- ✓ Selectable 6s/180s delay time.
- ✓ Air conditioner starter push offers very high current for 30 seconds to allow air conditioner to start.
- ✓ USB charger let you charge your smartphone, tablet, or any other peripheral with the built-in USB charger.
- ✓ Auto-run after Overload protection.

FEATURES



FARBER-COOLER™

Offers very high current for 30 seconds to allow air conditioners to start



FARBER-TRANSFER™

Instant transfer of power through zero-crossing detection



FARBER-TECHTOR™

Protects against over voltage



FARBER-TECHTOR™

Protects against under voltage



FARBER-TECHTOR™

Protects against over heat



FARBER-TECHTOR™

Protects against overload



LCD FEATURES

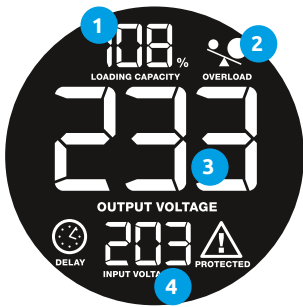

1. Loading capacity percentage
2. Overload warning
3. Output voltage
4. Input voltage

DISPLAY WARNINGS



Over voltage warning



Under voltage warning

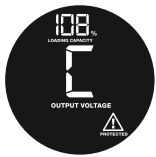

Overheat warning

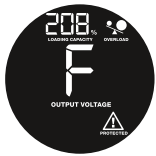

Overload warning

SPECIFICATION

MODEL NUMBER	FA-AVR-100-7000VA
Capacity	7000VA
Technology	FARBER-COLER/FARBER-TRANSFER
Transformer	Ultraslim toroidal transformer
Material	Metal
INPUT	
Input Voltage	100-220V
Input Frequency	45-65Hz
OUTPUT	
Rated Output Voltage	220V/230V
Output Precision	±8%
Output Frequency	Synchronized with input frequency
Efficiency	>97%
DISPLAY	
Digital Display	Input Voltage & Output Voltage
Green LED	power on
Yellow LED	Delaying
Red LED	Protecting
PROTECTIONS	
Over Voltage	Output Cutoff + warning
Under Voltage	Output Cutoff + warning
Overheat	Output Cutoff + warning
Short Circuit	Circuit breaker trip
Overload	Output Cutoff + warning
Surge	MOV
Delay Time	6s / 180 selectable
OTHERS	
Certifications	CE, SON, SB, SASD
Peripherals	USB Charging Port, Smart Cooling Fan
Operating Temperature	0°C-40°C
Storage Temperature	-15°C-45°C
Operating Humidity	10%-90%, Non-condensing
Dimensions	44.0 x 28.5 x 14.38
Quantity	1 piece



FARBER-TECHTOR™

Protects against short circuit



FARBER-WARNER™

In case of any fault or emergency, an alarm will sound



FARBER-RIGOUR™

5 relays ensure rigorous and high precision voltage outputs



FARBER-RESTARTER™

AVR will auto-run after overload protection



USB charger (OPTIONAL)

Charge your smartphone, tablet, or any other peripheral with the built-in USB charger

AVR RHO SERIES 140V

(15000VA, 20000VA)



APPLICATION



AC-2.5 Ton



AC-3.0 Ton

SCHEMATIC

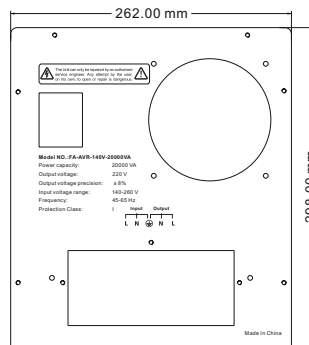
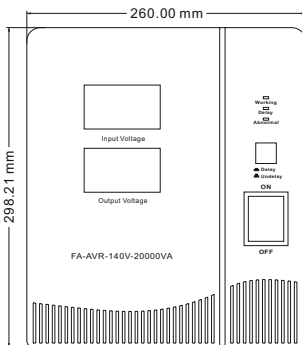

BENEFITS

- ✓ Classical panel design
- ✓ MCU controlled circuit offering precision output
- ✓ Zero cross transfer technology integrated
- ✓ High efficiency toroidal transformer
- ✓ FARBER patented CoolMate Technology optional
- ✓ Full protection: over voltage, under voltage, overheat, short circuit and overload
- ✓ Selectable 6s/180s delay time
- ✓ CE certified

FEATURES



FARBER-COOLER™
Offers very high current for 30 seconds to allow air conditioners to start



FARBER-TRANSFER™
Instant transfer of power through zero-crossing detection



FARBER-TECHTOR™
Protects against over voltage



FARBER-TECHTOR™
Protects against under voltage



FARBER-TECHTOR™
Protects against over heat



FARBER-TECHTOR™
Protects against overload



LCD FEATURES

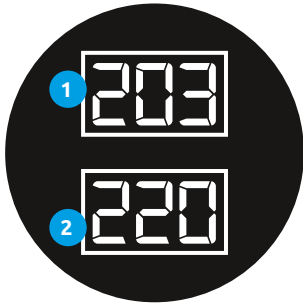

1. Input voltage display
2. Output voltage display

DISPLAY WARNINGS



Over voltage warning



Under voltage warning



Overheat warning



Overload warning

SPECIFICATION

MODEL NUMBER	FA-AVR-140V-15000VA	FA-AVR-140V-20KVA
Capacity	15000VA	20000VA
Technology	FARBER-COOLER, FARBER-TRANSFER	
Transformer	Toroidal transformer	
Material	Metal	
INPUT		
Input Voltage	140-260V	
Input Frequency	45-65Hz	
OUTPUT		
Rated Output Voltage	220V/230V	
Output Precision	±8%	
Output Frequency	Synchronized with input frequency	
Efficiency	>97%	
DISPLAY		
Digital Display	Input Voltage & Output Voltage	
Green LED	Power On	
Yellow LED	Delaying	
Red LED	Protecting	
PROTECTIONS		
Over Voltage	Output Cutoff + warning	
Under Voltage	Output Cutoff + warning	
Overheat	Output Cutoff + warning	
Short Circuit	Circuit breaker trip	
Overload	Output Cutoff + warning	
Surge	MOV	
Delay Time	6s / 180s selectable	
OTHERS		
Certifications	CE, SON, CB, SASO	
Peripherals	USB Charging Port, Smart Cooling Fan	
Operating Temperature	0°C - 40°C	
Storage Temperature	-15°C - 45°C	
Operating Humidity	10%-90%, Non-condensing	
Dimensions	42.5 x 26.0 x 31.5 cm	46.0 x 30.5 x 35.8 cm
Quantity	1 piece	
Net weight	18.5kg	22.5kg



FARBER-TECHTOR™

Protects against short circuit



FARBER-WARNER™

In case of any fault or emergency, an alarm will sound



FARBER-RIGOUR™

5 relays ensure rigorous and high precision voltage outputs



FARBER-RESTARTER™

AVR will auto-run after overload protection



USB charger

(OPTIONAL)
Charge any other peripheral with the built-in USB charger



Smart Cooling Fan

Built-in fan to keep the device cool in high temperature environments

ONLINE UPS PI SERIES

(3000VA, 6000VA, 10000VA, 20000VA)



BENEFITS

- ✓ True online double-conversion technology with high power density, utility frequency independence
- ✓ Three segment charging mode to increase battery service life, optimize recharge time
- ✓ Selectable High Efficiency mode of operation
- ✓ Cold start function to startup the UPS without utility
- ✓ Standard communication options
- ✓ Emergency, shutdown control through the remote emergency power-off (POE) port.
- ✓ Power shedding function may turn off uncritical load in battery backup to make longer backup time for critical load.

APPLICATION



Data center



Internet networks



Hospital & testing laboratories



Fire & alarm system



Servers

SCHEMATICS

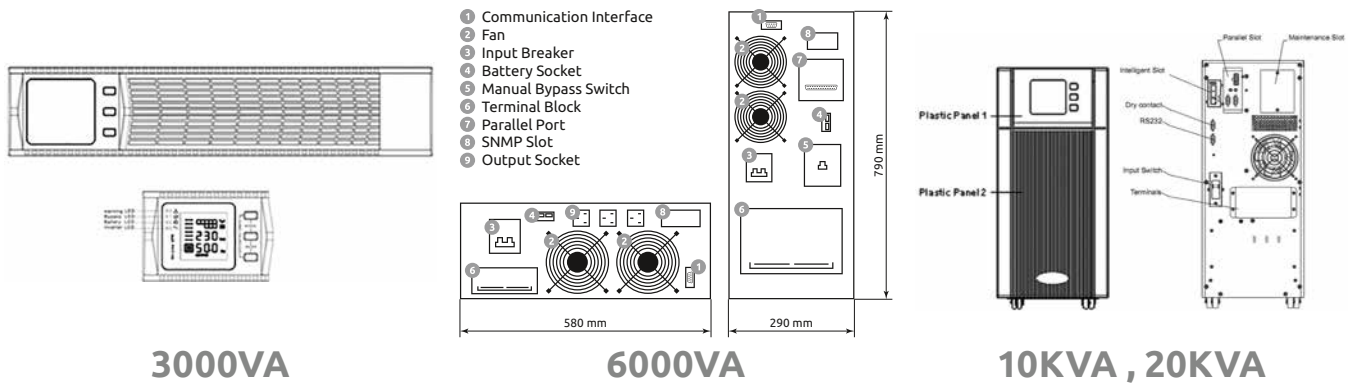

WIDE INPUT RANGE



WALL-MOUNTABLE DESIGN



FARBER-TRANSFER™
Instant transfer of power through zero-crossing detection



FARBER-TECHTOR™
Protects against overload

SPECIFICATION

MODEL	FA-UPS-72V-9AH/3000VA	FA-UPS-240V-7AH/6000VA	FA-UPS-96V-9AH/10KVA	FA-UPS-120V-9AH/20KVA
Capacity(VA/Watts)	3000VA	6000VA	10000VA	20000VA
INPUT				
Normal voltage	200V, 208V, 220V, 230V, 240V	220V, 230V, 240V	380V, 400V, 415V; (3Ph+N+PE)	
Operating voltage range	230V	170V-280V	208V-478V	
Operating frequency range	45-55HZ (50HZ) / 55-65HZ (60HZ) before transfer to battery	46-54HZ or 56-64HZ (auto sensing)	50HZ:45HZ:60HZ:54HZ:66HZ (auto sensing)	
Power factor	0,9	≥0.99	≥0.99	
OUTPUT				
Output voltage	200V, 208V, 220V, 230V, 240V	220V, 230V, 240V	220V, 230V, 240V	
Output frequency	50 or 60 auto sensing	50/60HZ (±1-10%)	50/60HZ (±1-10%)	
Harmonic distortion (THDv)	<3% THD or linear load; <5% on non-linear load	<2% (linear load)	≤5% with non-linear load	
Crest factor	3 to 1	3 to 1	3 to 1	
Efficiency	>93.5%	>90%	>93.5%	
BATTERY				
DC voltage	72V	240V	96V	120V
Battery type	12V/9AH	12V/7AH	12V/7AH/9AH	
Overload capability	loads 108-150%	105%-130%	load≤110%	
Transfer time	Main to battery :10ms maximum	Main to battery:1ms; Mains to Bypass:2ms	Main to battery:0ms; Mains to Bypass:0ms	
ENVIRONMENTAL				
operating temperature	0°C-40°C			
Storage temperature	-25°C-55°C			
Humidity range	0-90%			
Altitude	<1500m			
Noise level	<55dB			
PHYSICAL				
Dimension D*W*H (mm)	440 × 696 × 865	790 × 580 × 290	597 × 250 × 655	502 × 250 × 616



FARBER-TECHTOR™
Protects against short circuit



FARBER-TECHTOR™
Protects against over voltage



FARBER-TECHTOR™
Protects against under voltage



FARBER-WARNER™
In case of any fault or emergency, an alarm will sound